

ZG010A1-A

## **6. SATURDAY MECHANICS**

**Do-It-Yourself Maintenance**

# DO-IT-YOURSELF MAINTENANCE

JG020A2-A

## ENGINE COMPARTMENT

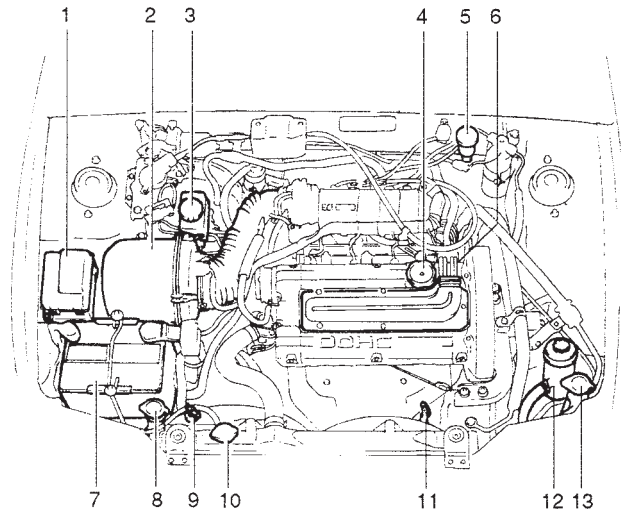

JR60019A

- |                           |   |   |
|---------------------------|---|---|
| 1. Relay box              | 6. Spark plug cable   | 10. Radiator cap                          |
| 2. Air cleaner            | 7. Battery  | 11. Engine oil level dipstick             |
| 3. Brake fluid reservoir  | 8. Engine coolant reservoir cap                                     | 12. Power steering fluid reservoir        |
| 4. Engine oil filler cap  | 9. Automatic transaxle fluid level dipstick<br>(Automatic T/A only) | 13. Windshield washer fluid reservoir cap |
| 5. Clutch fluid reservoir |   |   |

# DO-IT-YOURSELF MAINTENANCE

ZG020B2-A

## GENERAL EVERYDAY CHECKS

### Engine Compartment

The following should be checked regularly:

- o Engine oil level and condition
- o Transaxle fluid level and condition
- o Brake reservoir fluid level
- o Clutch reservoir fluid level
- o Engine coolant level
- o Windshield washer fluid level
- o Accessory drive belt condition
- o Engine coolant hose condition
- o Air cleaner filter element condition
- o Exhaust system condition
- o Fluid leaks (on or below components)
- o Power steering fluid level and condition
- o Tire pressure and condition (including spare)
- o Battery condition

ZG020C1-A

### Vehicle Exterior

The following should be checked monthly:

- o Overall appearance and condition
- o Wheel condition and wheel nut tightness
- o Exhaust system condition
- o Light condition and operation
- o Windshield glass condition
- o Wiper blade condition
- o Paint condition and corrosion
- o Fluid leaks
- o Door and hood lock condition

ZG020D1-A

### Vehicle Interior

The following should be checked each time when the vehicle is driven:

- o Light operation
- o Windshield wiper operation
- o Horn operation
- o Defroster, heating system operation (and air conditioning, if equipped)
- o Steering operation and condition
- o Mirror condition and operation
- o Turn signal operation
- o Accelerator pedal operation
- o Brake operation, including parking brake
- o Manual transaxle operation, including clutch operation
- o Automatic transaxle operation, including "Park" mechanism operation
- o Seat control condition and operation
- o Seat belt condition and operation
- o Sun visor operation

If you notice anything that does not operate correctly or appear to be functioning correctly, inspect it carefully and seek assistance from your Hyundai dealer if service is needed.

# DO-IT-YOURSELF MAINTENANCE

ZG030A1-A

## CHECKING THE ENGINE OIL

Engine oil is essential to the performance and service of the engine. It is suggested that you check the oil level at least once a week in normal use and more often if you are on a trip or driving in severe conditions.

ZG030B1-A

## Recommended Oil

SG or SG/CD (API) multi-grade and fuel efficient oil is recommended.

ZG030C1-A

## To Check the Oil Level

Before checking the oil, warm up the engine to normal operating temperature and be sure it is parked on level ground. Turn the engine off.

Wait a minute, then remove the dipstick, wipe it off, fully reinsert the dipstick and withdraw it again. Then note the highest level of oil has reached on the dipstick. It should be between the upper ("FULL") and lower ("LOW") range.

ZG030D1-A

## Adding Oil

If the oil level is close to or below the "LOW" mark, add oil until it reaches the "FULL" mark. To add oil:

1. Remove the oil filler cap by turning it counter-clockwise.
2. Add oil, then check the level again. Do not overfill.
3. Replace the cap by turning it clockwise.

The distance between the "FULL" and "LOW" marks is equal to about 1 quart of oil.

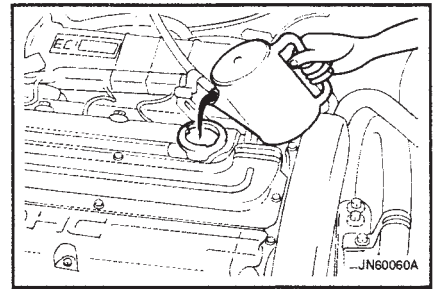
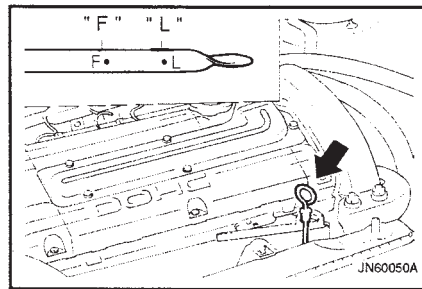
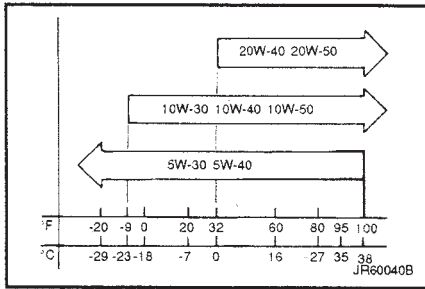

ZG040A1-A

## CHANGING THE OIL AND FILTER

The engine oil and filter should be changed at those intervals specified in the maintenance schedule in Section 5. If the car is being driven in severe conditions, more frequent oil and filter changes are required.

The procedure for changing the oil and filter is as follows:

1. Park the car on level ground and set the parking brake. Start the engine and let it warm up until the needle on the temperature gauge moves above the lowest mark. Turn the engine off and place the gear selector lever in "P" (automatic) or reverse gear (manual transaxle).
2. Open the hood and remove the engine oil filler cap.

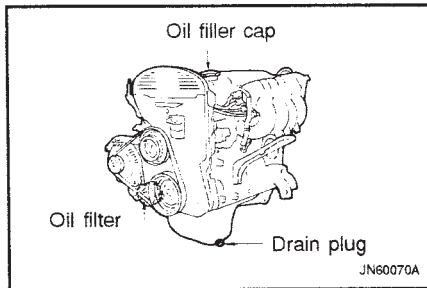

3. Slide underneath the car and loosen the drain plug by turning it counterclockwise with a wrench of the proper size. Be sure that a drain pan is in position to catch the oil as it drains out, then remove the drain plug.

### WARNING

**Be very careful when draining the engine oil as it may be hot enough to burn you!**

4. When the oil has stopped draining, replace the drain plug using a new washer and retighten by turning it clockwise.
5. Remove the oil filter. You should be able to unscrew the filter with your hands. (If your hands are slippery, try using a cloth between your hands and the filter to give yourself a better grip.) A certain amount of oil will come out when you remove the filter so be sure to have your drain pan in place underneath it.
6. Install a new oil filter in accordance with the instructions on the carton or on the filter itself. Do not over-tighten. Be sure that the mounting surface on the engine is clean and that the old gasket is removed completely. Lubricate the new gasket on the filter before installation with clean engine oil.
7. Refill the crankcase with the recommended engine oil. Refer to the specification in chapter 9 for engine oil capacity.
8. Start the engine and check to be sure no oil is leaking from the drain plug or oil filter.
9. Shut off the engine and recheck the oil level.

### NOTE:

**Always dispose of used engine oil in an environmentally acceptable manner. It is suggested that it be placed in a sealed container and taken to a service station for reclamation. Do not pour the oil on the ground or put it into the household trash.**

### WARNING

**Used motor oil may cause irritation or cancer of the skin if left in contact with the skin for prolonged periods of time. Wash your hands thoroughly with soap and warm water as soon as possible after handling used oil.**

ZG050A2-A

## CHECKING AND CHANGING THE ENGINE COOLANT

### WARNING

**Do not remove the radiator cap when the engine is hot. When the engine is hot, the engine coolant is under pressure and may erupt through the opening if the cap is removed. You could be seriously burned if you do not observe this precaution. Do not remove the radiator cap until the radiator is cool to the touch.**

ZG050B2-A

### Recommended Engine Coolant

Use a high quality ethylene-glycol coolant in a 50/50 mix with water. The engine coolant should be compatible with aluminum engine parts. No additional corrosion inhibitors or additives should be used. The cooling system must be maintained with the correct concentration and type of engine coolant to prevent freezing and corrosion.

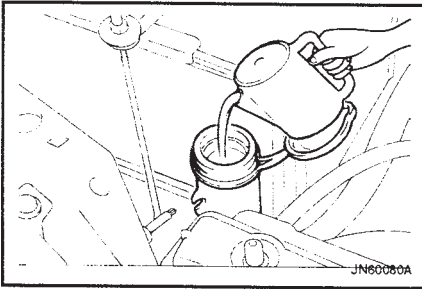

NEVER allow the concentration of antifreeze to exceed the 60% level or go below the 35% level or damage to the cooling system may result. For proper concentration when adding or replacing the engine coolant, refer to the following table.

Ambient temperature °C ( °F)	Engine Coolant concentration	
	Antifreeze solution	Water
-15 (5)	35%	65%
-25 (-13)	40%	60%
-35 (-31)	50%	50%
-45 (-49)	60%	40%

ZG050C1-A

### To Check the Engine Coolant Level

The engine coolant level can be seen on the side of the plastic engine coolant reservoir. The level of the engine coolant should be between the

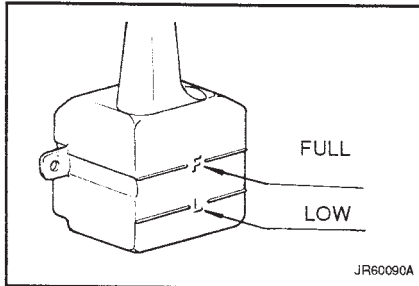

"LOW" and "FULL" lines on the reservoir. If the level is below the "LOW" mark, add engine coolant to bring it up between "LOW" and "FULL". If the level is low, inspect for engine coolant leaks and recheck the fluid level frequently. If the level drops again, visit your Hyundai dealer for an inspection and diagnosis of the reason.

ZG050D1-A

### To Change the Engine Coolant

The engine coolant should be changed at those intervals specified in the vehicle maintenance schedule in Section 5.

### CAUTION:

**Engine coolant can damage the finish of your car. If you spill engine coolant on the car, wash it off thoroughly with clear water.**

1. Park the car on level ground, set the parking brake and remove the radiator cap when cool.
2. Be sure your drain receptacle is in place. Open the drain cock on the radiator. Allow all the engine coolant to drain from the cooling system, then securely close the drain cock.
3. Check Section 9 for the capacity of the cooling system in your car. Then, following the manufacturer's directions on the engine coolant container, add the appropriate quantity of engine coolant to the radiator. Now fill the radiator with clean water. Continue to add water in small quantities until the fluid level stays up in the radiator neck.

4. Start the engine, top off the radiator with water and then add engine coolant to the reservoir until the level is between "LOW" and "FULL".
5. Replace the radiator and reservoir caps and check to be sure the drain cocks are fully closed and not leaking.

## WARNING

The cooling fan is controlled by engine coolant temperature and may sometimes operate even after the ignition key has been turned off. Use extreme caution when working near the blades of the cooling fan so that you are not injured by a rotating fan blade. As the engine coolant temperature decreases, the fan will automatically shut off. This is a normal condition.

ZG060A1-A

## REPLACING THE SPARK PLUGS

The spark plugs should be changed at the intervals specified in the vehicle maintenance schedule in section 5, or whenever engine performance indicates they should be changed. Symptoms that suggest poor spark plug performance include engine misfiring under load, loss of fuel economy, poor acceleration, etc. When spark plugs are replaced, always use spark plugs recommended by Hyundai. The use of other spark plugs can result in loss of performance, radio interference or engine damage.

### Recommended Spark Plugs:

CHAMPION : RN9YC4

NGK : BUR6EA-11

BPR6ES-11

JG060B1-A

## Changing the Spark Plugs

You will find it easier to change spark plugs if the engine is cold.

Always change one spark plug at a time. This helps avoid getting the spark plug wires mixed up.

1. Remove the center cover on the engine rocker cover.
2. Using a clean cloth, remove any dirt that has accumulated around the spark plug so it cannot fall into the cylinder when the spark plug is removed.
3. To remove the spark plug cable, pull straight up on the insulated connector, not the cable. Pulling on the cable may damage the carbon core conductor.

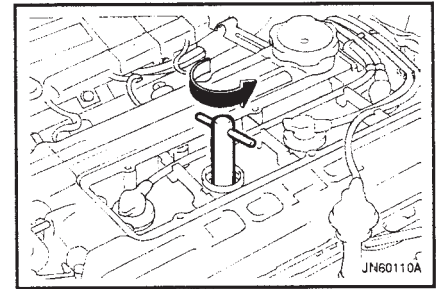
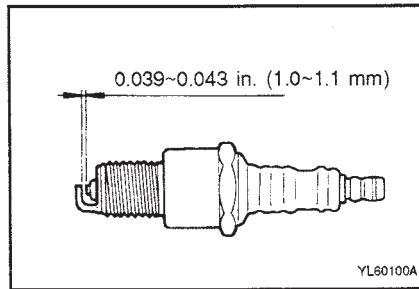

## DO-IT-YOURSELF MAINTENANCE

### WARNING

It is recommended that the engine be cool or cold when changing the spark plugs. If the engine is hot, you could burn yourself on the insulated connector, the spark plug or the engine itself.

4. When preparing to remove the old spark plug, guide the socket down over the spark plug, being careful not to damage the ceramic insulator.
5. To remove the spark plug, turn the wrench handle in a counterclockwise direction.
6. To replace the new spark plug, guide the socket down over the spark plug, being careful not to damage the ceramic insulator.

### NOTE:

Spark plugs should be tightened properly. Over-tightening can damage the threads in the aluminum cylinder head. Leaving them too loose can cause the spark plug to get very hot and possibly result in damage to the engine.

7. Replace the cable by pushing the insulated connector directly down onto the electrode. Check to be sure it has snapped into place and can't fall off.

ZG070A1-A

### CHANGING THE AIR CLEANER FILTER

To change the filter, unsnap the clips (1) around the cover. When this is done, the cover can be lifted off, the old filter removed and the new filter put in its place. Genuine Hyundai replacement parts are recommended.

### CAUTION:

Operating your vehicle without a proper air cleaner filter in place may result in excessive engine wear.

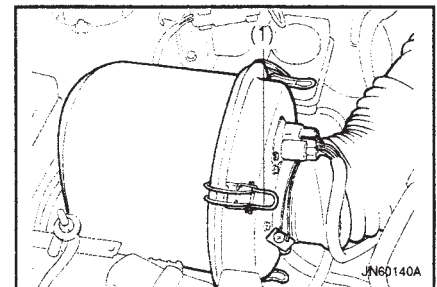
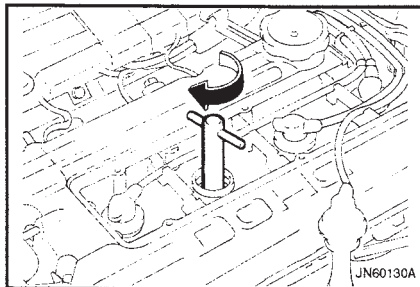
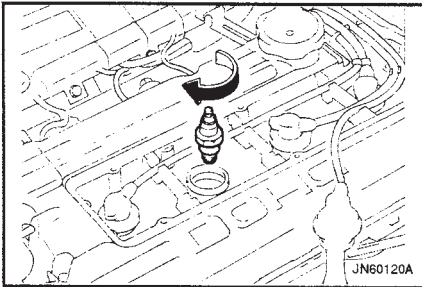



ZG090A1-A

## WINDSHIELD WIPER BLADES

The wiper blades should be carefully inspected from time to time and cleaned to remove accumulations of road film or other debris. To clean the wiper blades and arms, use a clean sponge or cloth with a mild soap or detergent and water. If the wipers continue to streak or smear the glass, replace them with genuine Hyundai replacement parts or their equivalent.

### CAUTION:

Do not operate the wipers on dry glass. This can result in more rapid wear of the wiper blades and may scratch the glass.

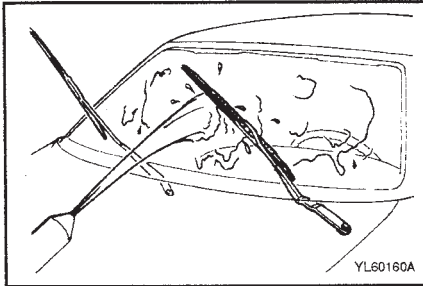

ZG090A1-A

## FILLING THE WASHER RESERVOIR

The washer fluid reservoir supplies fluid to the windshield washer system.

A good quality washer fluid should be used to fill the washer reservoir. The fluid level should be checked more frequently during bad weather or whenever the washer system is in more frequent use.

The capacity of the washer reservoir is 3.1 U.S. quarts (3.0 Liters).

### CAUTION:

- o Radiator antifreeze (engine coolant) should not be used in the washer system because it will damage the car's finish.
- o The washer lever should not be pulled and the washer should not be operated if the washer reservoir is empty. This can damage the washer fluid pump.

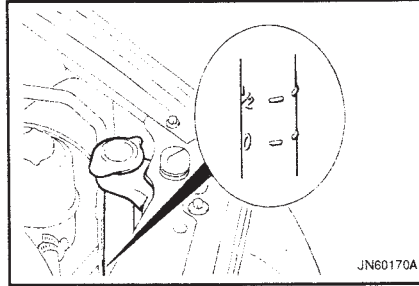

ZG100A2-A

## CHECKING THE TRANSAXLE OIL (MANUAL)

Transaxle lubricant in the manual transaxle should be checked at those intervals specified in the vehicle maintenance schedule in Section 5.

### Recommended Oil

Use only API GL-4 SAE 75W-85W or API GL-5 SAE 75W/90 in the manual transaxle.

### Manual Transaxle Oil Capacity

The oil capacity of the manual transaxle is 1.9 U.S. quarts (1.8 liters).

### WARNING

It is always better to check the transaxle oil level when the engine is cool or cold. If the engine is hot, you should exercise great caution to avoid burning yourself on hot engine or exhaust parts.

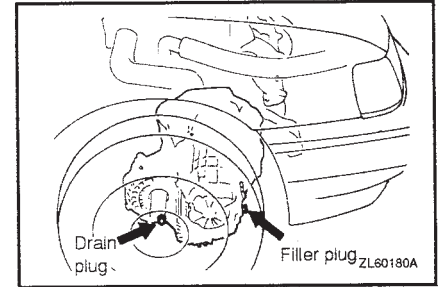

## DO-IT-YOURSELF MAINTENANCE

ZG100B1-A

### To check the Transaxle Fluid Level

Park the car on level ground with the engine off.

1. Using a wrench of the correct size, loosen the oil filler plug by turning it counterclockwise and remove it with your fingers.
2. Use your finger to feel inside the hole. The oil level should be at its bottom edge. If it is not, check for leaks before adding oil. To refill the transaxle or bring the oil level up, add oil slowly until it reaches the proper level. Do not overfill.
3. Replace the plug, screw it in with your fingers and then tighten securely with the wrench.

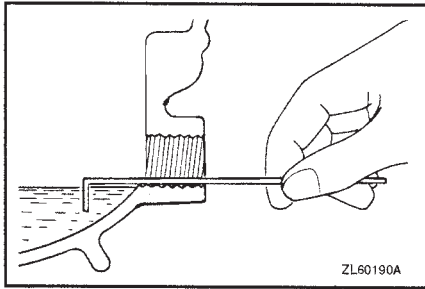

ZG110A1-A

### CHECKING THE TRANSAXLE FLUID (AUTOMATIC)

Transaxle fluid in the automatic transaxle should be changed at those intervals specified in the vehicle maintenance schedule in Section 5.

ZG110B3-A

### Recommended Fluid

Your Hyundai automatic transaxle is specially designed to operate with GENUINE HYUNDAI AUTOMATIC TRANSAXLE FLUID, MOPAR ATF PLUS TYPE 7176, DIAMOND ATF SP or other equivalent transaxle fluid.

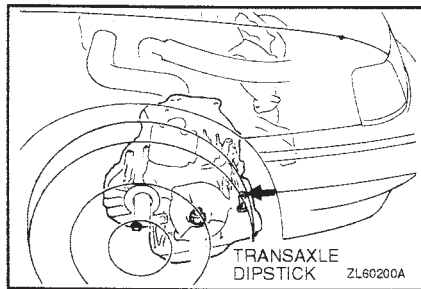

ZG110C1-A

### Transaxle Fluid Capacity

The fluid capacity of the automatic transaxle is 6.44 U.S. quarts (6.1 liters).

### WARNING

The transaxle fluid level should be checked when the engine is at normal operating temperature. This means that the engine, radiator, exhaust system etc., are very hot. Exercise great care not to burn yourself during this procedure.

ZG110D2-A

### To Check the Transaxle Fluid Level

Park the car on level ground with the parking brake engaged. When the transaxle fluid level is checked, the transaxle fluid should be at normal operating temperature and the engine idling.

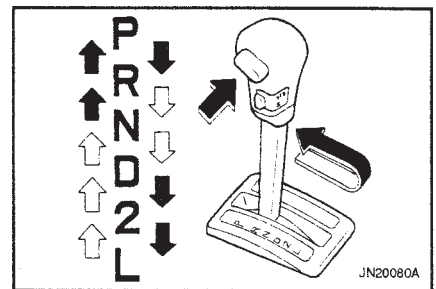

While the engine is idling, apply the brakes and move the gear selector lever from "P" to each of its other positions — "R", "N", "D", "2", "L" — and then return to "N". With the engine still idling:

1. Open the hood, being careful to keep hands, long hair, and clothing clear of any moving parts.
2. Remove the transaxle dipstick, wipe it clean, reinsert the dipstick as far as it will go, then remove it again. Now check the fluid level on the dipstick. It should be in the "HOT" range on the dipstick.
3. If the transaxle fluid level is low, use a funnel to add transaxle fluid through the dipstick tube until the level reaches the "HOT" range. Do not overfill.

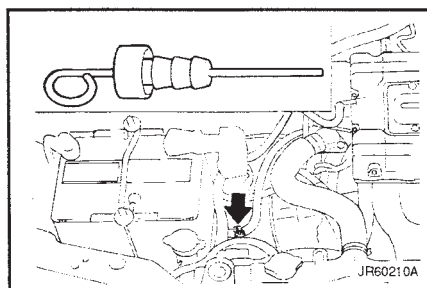

### WARNING

The cooling fan is controlled by engine coolant temperature and may sometimes operate even after the ignition key has been turned off. Use extreme caution when working near the blades of the cooling fan, so that you are not injured by a rotating fan blade. As the engine coolant temperature decreases, the fan will automatically shut off. This is a normal condition.

ZG120A1-A

### CHECKING THE BRAKES

#### CAUTION:

Because brakes are essential to the safe operation of the car, it is suggested that they be checked and inspected by your Hyundai dealer. The brakes should be checked and inspected for wear at those intervals specified in the vehicle maintenance schedule in Section 5.

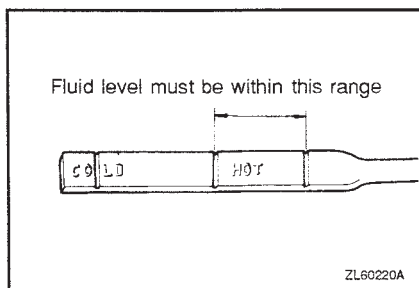

ZG120B1-A

### Checking the Brake Fluid Level

#### WARNING

Use caution when handling brake fluid. It can damage your vision if it gets into your eyes. It will also damage your vehicle's paint if spilled on it and not removed immediately.

ZG120C1-A

### Recommended Brake Fluid

Use only hydraulic brake fluid conforming to DOT 3 specifications in your braking system. Follow the instructions printed on the container.

ZG120D1-A

### To Check the Fluid Level

The fluid level in the brake fluid reservoir should be checked periodically. The level should be between the "MIN" and "MAX" marks on the side of the reservoir. If the level is at or below the "MIN" mark, carefully add fluid to bring it up to "MAX". Do not overfill.

## DO-IT-YOURSELF MAINTENANCE

ZG120E1-A

### Adding Brake Fluid

#### WARNING

Handle brake fluid carefully. It can damage your vision if it get into your eyes. Use only DOT 3 specification fluid from a sealed container. Do not allow the fluid can or reservoir to remain open any longer than required. This will avoid entry of dirt and moisture which can damage the brake system and cause improper operation.

To add brake fluid, first wipe away any dirt then unscrew the fluid reservoir cap. Slowly pour the recommended fluid into the reservoir. Do not over fill. Carefully replace the cap on the reservoir and tighten.

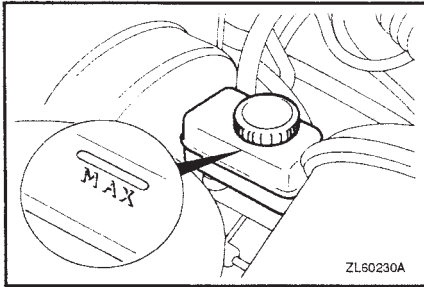

ZG130A1-A

### CHECKING THE CLUTCH FLUID

#### To Check the Clutch Fluid

The clutch fluid level in the master cylinder should be checked when performing other under hood services. The system should be checked for leakage at the same time.

Check to make certain that the clutch fluid level is between the "MAX" and "MIN" level markings on the fluid reservoir. Fill as required. Fluid loss indicates a leak in the clutch system which should be inspected and repaired immediately. Consult your Hyundai dealer.

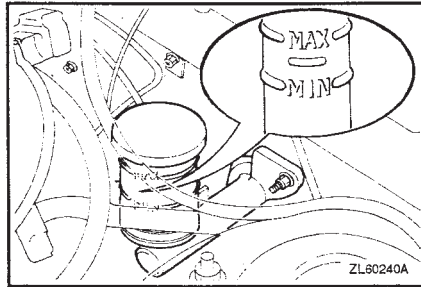

ZG130B1-A

### To Replace the Fluid

Recommended brake fluid conforming to DOT 3 specification should be used. The reservoir cap must be fully tightened to avoid contamination from foreign matter or moisture.

#### NOTE:

Do not allow any other liquids to contaminate the brake fluid. Seal damage will result.

#### WARNING

Use caution when handling brake fluid. It can damage your vision if you get it in your eyes. It will also damage your vehicle's paint if spilled on it and not removed immediately.

# DO-IT-YOURSELF MAINTENANCE

ZG140A1-A

## AIR CONDITIONING CARE

### Keeping the Condenser Clean

The air conditioning condenser (and engine radiator) should be checked periodically for accumulation of dirt, dead insects, leaves, etc. These can interfere with maximum cooling efficiency. When removing such accumulations, brush or hose them away carefully to avoid bending the cooling fins.

ZG140B1-A

### Checking the Compressor Drive Belt

When the air conditioning is being used regularly, the compressor drive belt tension should be checked at least once a month. To check the drive belt tension, press down on the belt halfway between the engine crankshaft and compressor pulleys. Pressing with your finger, you should not be able to deflect this belt any more than one-half inch. If you have the instruments to check it, with a force of 22 lb. (98N), the deflection should be 0.31-0.39 inches (8-10 mm). If the belt is too loose or too tight have it adjusted by your Hyundai dealer.

ZG140C1-A

### Checking the Air Conditioning Operation

1. Start the engine and let it run at fast idle for several minutes with the air conditioning set at the maximum cold setting.
2. If the air coming out of the in-dash vents is not cold, have the air conditioning system inspected by your Hyundai dealer.

#### CAUTION:

**Running the air conditioning system for extended periods of time with a low refrigerant level may damage the compressor.**

ZG140D1-A

### Lubrication

To lubricate the compressor and the seals in the system, the air conditioning should be run for at least 10 minutes each week. This is particularly important during cool weather when the air conditioning system is not otherwise in use.

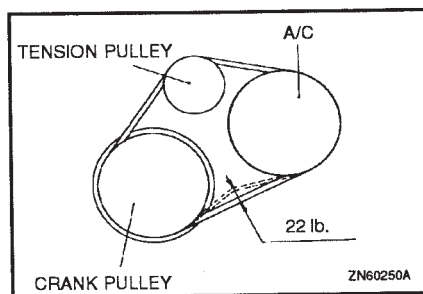

## DO-IT-YOURSELF MAINTENANCE

ZG150A1-A

### CHECKING STEERING WHEEL FREEPLAY

To check the steering wheel freeplay, stop the car with the wheels pointed straight ahead and gently move the steering wheel back and forth. Use very light finger pressure and be sensitive to changes in resistance that mark the limits of the freeplay. If the freeplay is greater than specified, have it inspected by your Hyundai dealer and adjusted or repaired if necessary.

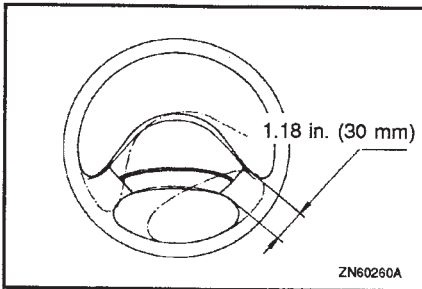

6-14

ZG160A1-A

### CHECKING CLUTCH PEDAL FREEPLAY

With the engine off, press lightly on the clutch pedal until you feel a change in resistance. This is the clutch pedal freeplay. The freeplay should be within the limits specified. In the illustration below. If it is not, have it inspected by your Hyundai dealer and adjusted or repaired if necessary.

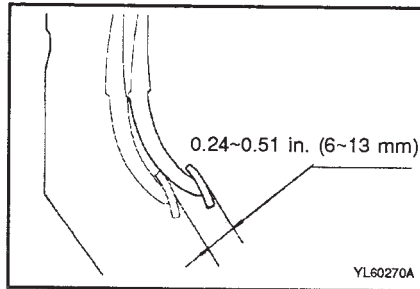

ZG170A1-A

### CHECKING BRAKE PEDAL FREEPLAY

With the engine off, press down on the brake pedal several times to reduce the vacuum in the brake booster.

Then, using your hand, press down slowly on the brake pedal until you feel a change in resistance. This is the brake pedal freeplay.

The freeplay should be within the limits specified in the illustration below. If it is not, have it inspected by your Hyundai dealer and adjusted or repaired if necessary.

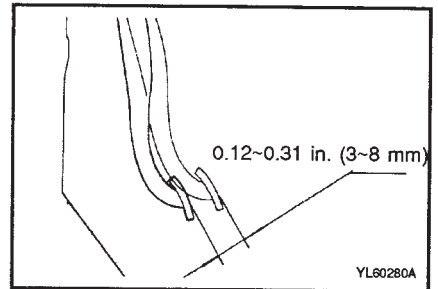

ZG180A1-A

## CHECKING BRAKE PEDAL CLEARANCE

You need a helper to check the brake pedal clearance. With the engine running, have your helper press down on the brake pedal several times and then hold it down with a force of about 110 lbs (50 kg, 490 N). The brake pedal clearance is the distance from the top surface of the brake pedal to the asphalt sheeting under the floor mat.

If the brake pedal clearance is not within the limits specified in the illustration, have it inspected by your Hyundai dealer and adjusted or repaired if necessary.

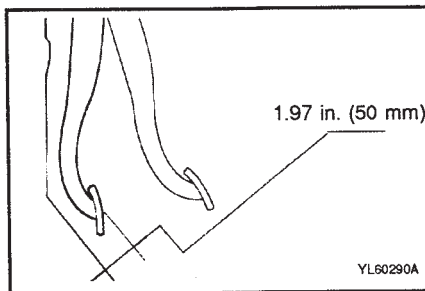

ZG190A1-A

## CHECKING DRIVE BELTS

Drive belts should be checked periodically for proper tension and adjusted if necessary. At the same time, belts should be examined for cracks, wear, fraying or other evidence of deterioration and replaced if necessary.

Belt routing should also be checked to be sure there is no interference between the belts and other parts of the engine. After a belt is replaced, the new belt should be adjusted again after two or three weeks to eliminate slack resulting from initial stretching after use.

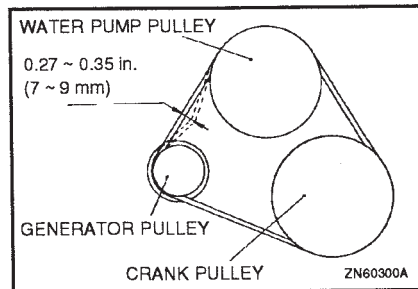

ZG200A1-A

## CHECKING AND REPLACING FUSES

### Replacing a Fusible Link

A fusible link will melt if the electrical circuits from the battery are ever overloaded, thus preventing damage to the entire wiring harness. (This could be caused by a short in the system drawing too much current.) If this ever happens, have a Hyundai dealer determine the cause, repair the system and replace the fusible link. The fusible links are located in a holder next to the battery for easy inspection.

### CAUTION:

**When replacing a fusible link, never use anything but a new fusible link with the same or lower amperage rating. Never use a piece of wire or a higher-rated fusible link. This could result in serious damage and create a fire hazard.**

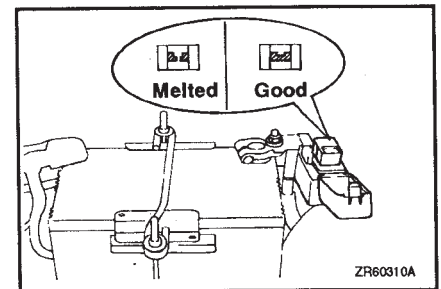

## DO-IT-YOURSELF MAINTENANCE

ZG200B1-A

### Replacing Accessory Fuse

The fuse box for the lights and other electrical accessories will be found low on the dashboard on the driver's side. Inside the box you will find a list showing the circuits protected by each fuse. If any of your car's lights or other electrical accessories stop working, a blown fuse could be the reason. If the fuse has burned out, you will see that the metal strip inside the fuse has burned through. If you suspect a blown fuse, follow this procedure:

1. Turn off the ignition and all other switches.
2. Open the fuse box and examine each fuse. Remove each fuse by pulling it toward you (a small "fuse puller" tool is contained in the fuse box to simplify this operation).

3. Be sure to check all other fuses even if you find one that appears to have burned out.
4. Replace the blown fuse by pressing a new fuse of the same rating into place. The fuse should be a snug fit. If it is not, have the fuse clip repaired or replaced by a Hyundai dealer. If you do not have a spare fuse, you may be able to borrow a fuse of the same or lower rating from an accessory you can temporarily get along without (the radio or cigarette lighter, for example). Always remember to replace the borrowed fuse.

### CAUTION:

A burned-out fuse indicates that there is a problem in the electrical circuit. If you replace a fuse and it blows as soon as the accessory is turned on, the problem is serious and should be referred to a Hyundai dealer for diagnosis and repair. Never replace a fuse with anything except a fuse with the same or a lower amperage rating. A higher capacity fuse could cause damage and create a fire hazard.

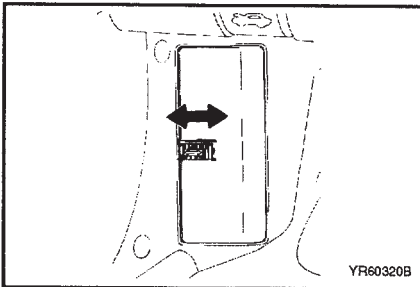

6-16

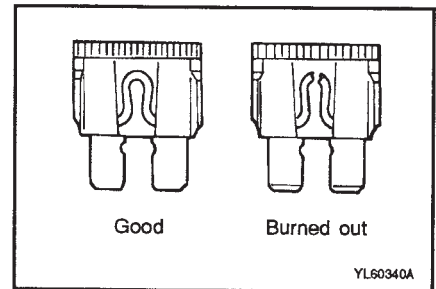
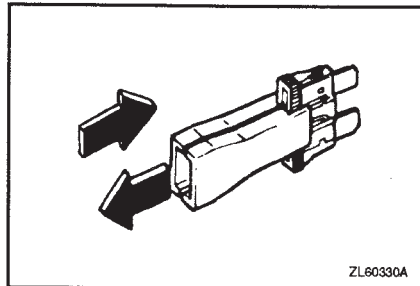



ZG210A1-A

## CHECKING THE BATTERY

### WARNING

**When working with batteries, carefully observe the following precautions to avoid serious injuries.**

The fluid in the battery contains a strong solution of sulfuric acid, which is poisonous and highly corrosive. Be careful not to spill it on yourself or the car. If you do spill battery fluid on yourself, immediately do the following:

- o If battery fluid is on your skin, flush the affected areas with water for at least 15 minutes and then seek medical assistance.
- o If battery fluid is in your eyes, rinse out your eyes with water and get medical assistance as soon as possible. While you are being driven to get medical assistance, continue to rinse your eyes by using a sponge or soft cloth saturated with water.
- o If you swallow battery fluid, drink a large quantity of water or milk followed by milk of magnesia, eat a raw egg or drink vegetable oil. Get medical assistance as soon as possible.

While batteries are being charged (either by a battery charger or by the vehicle's generator), they produce explosive gases. Always observe these warnings to reduce the risk of injury:

- o Charge batteries only in a well ventilated area.
- o Do not permit flames, sparks or smoking in the area.
- o Keep children away from the area.

ZG210B1-A

### Checking the Battery

Keep the battery clean. Any evidence of corrosion around the battery posts or terminals should be removed using a solution of household baking soda and warm water. After the battery terminals are dry, cover them with a light coating of grease.

ZG220A2-A

## CHECKING ELECTRIC COOLING FANS

### WARNING

**The cooling fan is controlled by engine coolant temperature and may sometimes operate even after the ignition key has been turned off. Use extreme caution when working near the blades of the cooling fan, so that you are not injured by a rotating fan blade. As the engine coolant temperature decreases the fan will automatically shut off. This is a normal condition.**

### Checking Engine Cooling Fan

The engine cooling fan should come on automatically if the engine coolant temperature is high.

### Checking Condenser Cooling Fan

The condenser cooling fan should come on automatically whenever the air conditioning is in operation.

## DO-IT-YOURSELF MAINTENANCE

JG230A2-A

### POWER STEERING FLUID LEVEL

The power steering fluid level should be checked daily.

To check the power steering fluid level, be sure the ignition is "OFF", then check to make certain that the power steering fluid level is between the "MAX" and "MIN" level markings on the fluid reservoir.

#### NOTE:

Grinding noise from the power steering pump may be heard immediately after the engine is started in extremely cold conditions (below -4 °F). In this case, if the noise stops during warm up, there is no abnormal function in the system. This is due to a power steering fluid characteristic in extremely cold conditions.

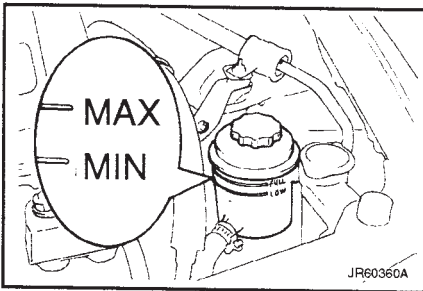

6-18

### Recommended Fluid

Use ATF Dexron II type fluid.

#### NOTE:

Do not start the engine when the power steering oil reservoir is empty.

ZG230B1-A

### POWER STEERING HOSES

It is suggested that you check the power steering hose connections for fluid leakage daily. The power steering hoses should be replaced if there is severe surface cracking, pulling, scuffing or worn spots. Deterioration of the hoses could cause premature failure.

ZG240A1-A

## FOR MORE INFORMATION ABOUT YOUR HYUNDAI

If you desire additional information about maintaining and servicing your Hyundai, you may purchase a factory Shop Manual at your Hyundai dealer's parts department. This is the same manual used by dealership technicians and while it is highly technical it can be useful in obtaining a better understanding of your car and how it works.

ZG250A1-A

## REPLACING LIGHT BULBS

Before attempting to replace a light bulb, be sure the switch is turned to the "OFF" position. The drawings on the next pages show how to reach light bulbs so they may be changed. Be sure to replace the burned-out bulb with one of the same number and wattage rating.

ZG260A1-A

## HEADLIGHT

### REPLACEMENT INSTRUCTIONS:

1. Allow the bulb to cool. Wear eye protection.
2. Always grasp the bulb by its plastic base, avoid touching the glass.
3. Unscrew the locking collar securing the bulb.
4. Disconnect the power cord from the bulb base in the back of the headlight and remove the used bulb from the headlight.

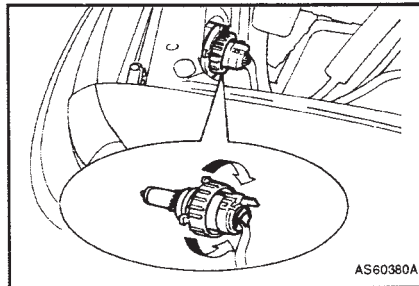

5. Remove the protective cap from the replacement bulb and install the new bulb by matching the plastic base with the headlight hole. Reconnect the power cord and re-tighten the locking collar.
6. Use the protective cap and carton to promptly dispose of the old bulb.
7. Check for proper headlight aim.

### WARNING

**This halogen bulb contains gas under pressure and if impacted could shatter, resulting in flying fragments. Always wear eye protection when servicing the bulb. Protect the bulb against abrasions or scratches and against liquids when lighted. Turn on the bulb only when installing in a headlight. Replace the headlight if damaged or cracked. Keep the bulb out of the reach of children and dispose of the used bulb with care.**

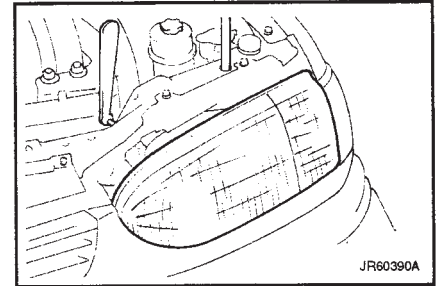

## DO-IT-YOURSELF MAINTENANCE

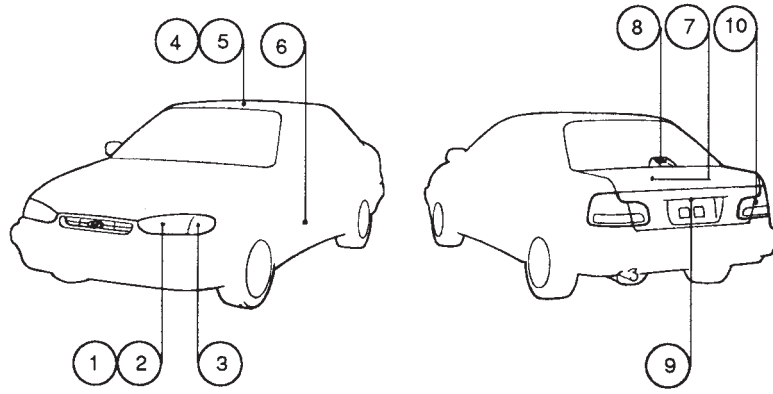

JR60400A

No.	Part Name	Wattage	No.	Part Name	Wattage	
1	Headlight	65/45	8	High Mounted Rear Stop Light	5	
2	Front Side Marker Light	5	9	License Plate Light	8	
3	Front Combination Light	5	10	Rear Combination Light	27	
4	Interior Light (With sunroof)	10/8		Turn Signal Light		
5	Interior Light (Without sunroof)	8		Stop/Tail Light		27/8
6	Door Light (If installed)	5		Back-up Light		27
7	Luggage Compartment Light	5				